



## RV4LAYS503A

**RV4 Series Industrial Potentiometer, Conductive Plastic Element, Solder lug Terminals, 2 W Power Rating, 50 kOhm Resistance Value**

*Representative photograph, actual product appearance may vary.*

*Due to regional agency approval requirements, some products may not be available in your area. Please contact your regional Honeywell office regarding your product of choice.*

### Features

- Robust nickel-plated brass shaft and bushings
- Conductive plastic element
- Linear taper
- 25,000 cycle rotational life
- Meets MIL-PRF-94 standards
- Locking style bushing

### Typical Applications

- Manual controls (throttle, joystick)
- Electric vehicles
- Personal mobility
- Off-road vehicles
- Welding and heating
- Telecommunications

### Description

The RV4 Series is a military qualified potentiometer made in accordance to MIL-PRF-94 specifications. It offers a 2 watt power rating and a conductive plastic element.

## RV4LAYS503A

**RV4 Series Industrial Potentiometer, Conductive Plastic Element, Solder lug Terminals, 2 W Power Rating, 50 kOhm Resistance Value**

Product Specifications	
Potentiometer Type	Industrial
Element Type	Conductive Plastic
Terminal Type	Solder lug
Power Rating	2 W
Resistance Value	50 kOhm
Resistance Tolerance	± 10 %
Linearity	± 5 %
Bushing Thread	9,53 mm [0.375 in] x 32 NEF-2A
Bushing length	12,7 mm[0.5 in]
Bushing Type	Locking
Shaft Diameter	6,35 mm [0.25 in]
Shaft length	15,88 mm [0.625 in]
Shaft Ending	Slotted
Body	27.8 mm [1.094 in] diameter max. except at terminal standoff
Electrical Taper	Linear
Operating Temperature	-55 °C to 120 °C [-67 °F to 248 °F]
Working Voltage (Max.)	500 V
Rotational Life	25000 cycles
Mechanical Rotation	312°
Availability	Global
Series Name	RV4 Series
UNSPSC Code	4111363300
UNSPSC Commodity	4111363300 Potentiometers

**Honeywell**

## RV4LAYSA503A

RV4 Series Industrial Potentiometer, Conductive Plastic Element, Solder lug Terminals, 2 W Power Rating, 50 kOhm Resistance Value

For Reference Only mm/in

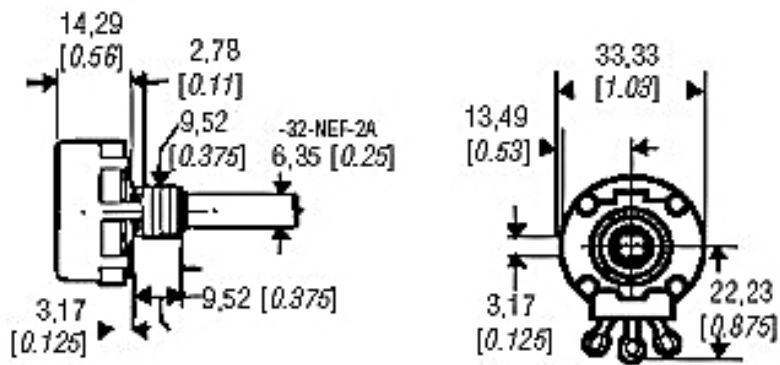

RV4N

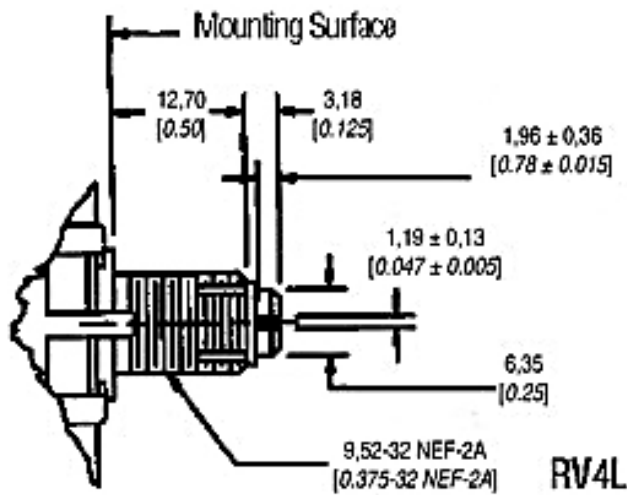

**Honeywell**

## RV4LAYSA503A

RV4 Series Industrial Potentiometer, Conductive Plastic Element, Solder lug Terminals, 2 W Power Rating, 50 kOhm Resistance Value

** WARNING**

**PERSONAL INJURY**

DO NOT USE these products as safety or emergency stop devices, or in any other application where failure of the product could result in personal injury.

**Failure to comply with these instructions could result in death or serious injury.**

** WARNING**

**MISUSE OF DOCUMENTATION**

- The information presented in this product sheet (or catalog) is for reference only. DO NOT USE this document as product installation information.
- Complete installation, operation and maintenance information is provided in the instructions supplied with each product.

**Failure to comply with these instructions could result in death or serious injury.**